

TA-SCOPE





Note! The products, texts, photographs, graphics and diagrams in this brochure may be subject to alteration by IMI Hydronic Engineering without prior notice or reasons being given. For the most up to date information about our products and specifications, please visit www.imi-hydronic.com.

IMI International Sp. z o.o., Olewin 50A, 32-300 Olkusz, Poland.

*TA-SCOPE includes software licensed from OMRON SOFTWARE Co., Ltd.
Advanced Wnn® OMRON SOFTWARE Co., Ltd. 2002 – 2010.
All rights reserved.*

Contents

End User License Agreement.....	5
Introduction	7
Instrument and Measuring Equipment.....	8
Guide to Manual and Instrument.....	9
Handheld	9
Abbreviations	9
Display and Keypad.....	10
Handheld.....	10
Display Information Bar Icons	10
Keypad Keypad Icons	10
Functional Contents	11
DpS-Visio	12
Measuring Preparations	14
Prerequisites for Balancing with TA-SCOPE	14
Switch on/off the units	14
Wireless Communication	14
Connect / Disconnect Measuring Equipment	15
Calibration of Dp Sensor	16
Handwheel	16
Connections for Cables	16
Hydronic Functions.....	17
Quick Measure	18
Measure Flow	18
View Saved Measurements	19
Flow Adjustment – Computer Method	19
Measure Differential Pressure (Δp)	20
Measure Temperature	20
Measure Power	21
Hydronic Networks	23
Navigate Hydronic Networks	23
Edit Existing Network	23
Delete Network	24
Create a Hydronic Network	24
Balancing.....	25
Balance a Hydronic Network with TA-Diagnostic	25
Balance a Hydronic Network with TA-Wireless	26
Modify or Define New Module	28
Troubleshooting	29
Diagnose a Hydronic Network with TA-Diagnostic	29
Use the Required Dp on Circuit Troubleshooting Wizard	29
Data Logging.....	30
Start a New Logging	30
Download Loggings	31
View Loggings	31
Support Functions	33
Fluid	34
Change Fluid	34
Hydronic Calculator	35
Calculate Flow/Cv/Dp (Δp)/Power/DT (ΔT)	35
Calculate Valve Opening	35
Recommend Pipe Dimension	35
Recommend Valve Dimension	36
Unit Conversion	36

Settings	37
Information	39
PC Communication	40
Transfer of Data	40
Software Upgrade	40
Instrument Care and Service.....	41
Batteries – Capacity & Charging	41
Charging – Operation instruction	41
Filter Cleaning	42
Calibration Certificates	42
Guarantee.....	43
FCC Notification and ETL Markings	44
Technical Specifications.....	45
Accessories	46



CAUTION! Read the user manual before using the product.



Warning! Beware of hot fluid in the valve. Always follow the sequence described in the manual when connecting and disconnecting the measuring equipment.

Water temperature over 125°F (52°C) can cause severe burns instantly or death from scalds. Always consider the risks of injury from hot water before starting any measurement on a heating system and follow relevant local legislation, regulations, standards and good industry practice for working with pressurised hot water systems. Always use appropriate personal safety equipment when working on a heating system. Examples of appropriate safety equipment include (but are not limited to) a face shield, heat resistant rubber gloves and boots and a long sleeved apron (long enough to cover the tops of the boots). Always wear your boots inside your trouser legs to prevent/minimise any hot water flowing into your boots. IMI Hydronic Engineering will not take any responsibility for injury howsoever caused by hot water during measurement.



Warning! The surface on the Dp Sensor can be hot while measuring on hot media. Always use suitable safety equipment.



Warning! Do not open the instrument. This can damage the instrument and void your guarantee! See page 43 for further information.



Warning! Both Handheld and Dp Sensor contain batteries which require charging. The supplied multi-charger from IMI Hydronic Engineering must be used!



CAUTION! (Multi-charger)

1. Do not bend the blade or pins of the plug.
2. If there are any strange sound, smoke or odor, pull of the cable(s) immediately.
3. Do not disassemble. (it may cause fire or electric shock).
4. Do not put any sharp objects into the venting hole. (it may cause fire or electric shock).
5. Ensure to plug the multi-charger firmly.
6. Ensure not to use damaged cable(s). (it may cause fire or electric shock).
7. Ensure not to place the multi-charger on a bed, bag or inside a closet that is not good for ventilation.
8. Always wipe off the multi-charger with a soft fabric, not water mop. (water may cause electric shock).
9. Keep the power plug and outlet clean. (dirt may cause a short circuit and fire).
10. Keep the product out of reach of children.

End User License Agreement

By using TA-SCOPE or the Software, you acknowledge that you have read this agreement (“Agreement”), understood the content of it and agree to be bound by the terms of this Agreement. If you do not agree to the terms of this Agreement, you are not permitted to use TA-SCOPE or the Software.

This Agreement is entered into between IMI Hydronic Engineering and the “End User”.

1. Definitions

“Documentation” means the manual, the tutorial and other materials related to the Software, provided to the End User.

“End User” means any person or company who is entitled to use the Software according to this Agreement.

“Software” means the software, Documentation, including any updates and upgrade thereto, for the TA-SCOPE which is provided to an End User under this Agreement.

“TA-SCOPE” means the instrument manufactured and sold by IMI Hydronic Engineering used for hydronic balancing and troubleshooting of HVAC systems, currently named TA-SCOPE.

2. License grant

2.1 Subject to the terms and conditions set forth in this Agreement and the payment of all applicable fees charged by IMI Hydronic Engineering for TA-SCOPE, IMI Hydronic Engineering grants End User a non-exclusive, non-transferrable license to use the Software on a single TA-SCOPE device, provided however that this Agreement does not grant End User any title or right of ownership in or to the Software.

2.2 The Software shall be used only for End User’s own computing requirements in accordance with the terms and conditions set forth herein, and only in combination with the TA-SCOPE.

3. Restricted use

3.1 End User shall not use the Software for any purposes other than the use specified in Section 2.2.

3.2 End User shall not make, have made or permit its employees or third parties to make, any copies or verbal or media translations of the Software, in whole or part, for any reason. End User shall not use or allow the Software to be used, directly or indirectly, in any manner that would enable any person or entity to copy or use the Software or part thereof.

3.3 End User shall not use the Software on any TA-SCOPE that End User does not own or control, and End User may not distribute or make the Software available to any third party. End User may not assign, transfer, rent, lease, lend, sell, redistribute or sublicense the Software.

3.4 In case End User permanently transfers all of its rights to the TA-SCOPE device, End User may include the license granted hereunder in such transfer, provided, however, that End User retains no copies of the Software, End User transfers all of the Software (including all component parts, the media and printed materials, any upgrades, all platforms, this Agreement, the serial numbers, and, if applicable, all other software products provided together with the Software), and End User ensures the recipient to agree and be bound by the terms of this Agreement.

3.5 END USER SHALL NOT MODIFY, DISASSEMBLE, DECOMPILE, RECREATE OR GENERATE ANY SOFTWARE OR ANY PORTION OR VERSION THEREOF UNLESS AND TO THE EXTENT PERMITTED UNDER APPLICABLE MANDATORY LAW.

3.6 End User shall not remove, erase or hide from view any copyright, trademark, confidentiality notice, mark or legend appearing on TA-SCOPE or in the Software or any form of output produced by the Software.

3.7 IMI Hydronic Engineering reserves its right to continuously without notification: (i) verify the validity of each license used by an End User; (ii) evaluate the Software; and (iii) to automatically update the Software.

4. No warranties

4.1 THE SOFTWARE IS PROVIDED "AS IS" WITH NO WARRANTIES WHATSOEVER. IMI HYDRONIC ENGINEERING DOES NOT, EITHER EXPRESSED, IMPLIED OR STATUTORY, MAKE ANY WARRANTIES, CLAIMS OR REPRESENTATIONS WITH RESPECT TO THE SOFTWARE, INCLUDING, WITHOUT LIMITATION, WARRANTIES OR CONDITIONS OF QUALITY, PERFORMANCE, NON-INFRINGEMENT, MERCHANTABILITY, OR FITNESS FOR USE FOR A PARTICULAR PURPOSE. IMI HYDRONIC ENGINEERING FURTHER DOES NOT REPRESENT OR WARRANT THAT THE SOFTWARE WILL ALWAYS BE AVAILABLE, ACCESSIBLE, UNINTERRUPTED, TIMELY, SECURE, ACCURATE, COMPLETE AND ERROR-FREE.

4.2 THE ENTIRE RISK ARISING OUT OF THE USE OR PERFORMANCE OF THE SOFTWARE REMAINS WITH END USER, E.G. END USER ASSUMES FULL RESPONSIBILITY FOR ITS USE OF THE SOFTWARE AND ANY INFORMATION ENTERED, USED AND STORED THEREON. END USER ASSUMES FULL RESPONSIBILITY FOR ENSURING THAT DATA IS NOT INADVERTENTLY MODIFIED, DELETED, DESTROYED OR DISCLOSED.

4.3 TO THE EXTENT NOT PROHIBITED BY APPLICABLE LAW, IN NO EVENT SHALL IMI HYDRONIC ENGINEERING BE LIABLE FOR ANY PRODUCT LIABILITY, LOSS OF OR DAMAGE TO REVENUES, PROFITS OR GOODWILL OR OTHER SPECIAL, INCIDENTAL, INDIRECT OR CONSEQUENTIAL DAMAGES OF ANY KIND, RESULTING FROM IMI HYDRONIC ENGINEERING'S PERFORMANCE OR FAILURE TO PERFORM PURSUANT TO THE TERMS OF THIS AGREEMENT, OR RESULTING FROM THE FURNISHING, PERFORMANCE, OR USE OR LOSS OF USE, LOSS OF DATA OR LOSS OF ANY SOFTWARE OR OTHER MATERIALS DELIVERED, INCLUDING, WITHOUT LIMITATION, ANY INTERRUPTION OF BUSINESS, EVEN IF END USER HAS BEEN ADVISED OF THE POSSIBILITY OF SUCH DAMAGES.

5. Intellectual Property rights

5.1 IMI Hydronic Engineering is the owner of all copyright, trademarks, patents, trade secrets and any other intellectual property rights which subsist in or relate to the Software and these properties shall always remain vested in IMI Hydronic Engineering.

5.2 Nothing in this Agreement shall be construed as a sale of the Software. Any and all rights not expressly granted by this Agreement to the End User are reserved by IMI Hydronic Engineering.

6. Term and termination

6.1 The license granted hereunder shall commence upon the execution of the agreement between IMI Hydronic Engineering and the End User's acceptance of the terms and conditions herein contained, and shall continue in effect unless terminated earlier pursuant hereto.

6.2 The license granted hereunder is effective until terminated by End User or IMI Hydronic Engineering. IMI Hydronic Engineering has the right to terminate the Agreement immediately if End User fails to comply with any term of this Agreement. Upon termination of the Agreement, End User shall cease all use of the Software, and destroy all copies, full or partial, thereof.

7. Disputes and governing law

7.1 Any dispute, controversy or claim arising out of, or in connection with, this Agreement, or the breach, termination or invalidity thereof, shall be finally settled by arbitration administered by the Arbitration Institute of the Stockholm Chamber of Commerce. The Rules for Expedited Arbitrations of the Arbitration Institute of the Stockholm Chamber of Commerce shall apply, unless the institute – taking into account the complexity of the case, the amount in dispute and other circumstances – determines, in its discretion, that the Arbitration Rules of the Arbitration Institute of the Stockholm Chamber of Commerce shall apply. In the latter case, the institute shall also decide whether the arbitral tribunal shall be composed of one or three arbitrators. The seat of arbitration shall be Gothenburg, Sweden. The language of the arbitration shall be English.

7.2 This Agreement shall be governed by and construed in accordance with the laws of Sweden, excluding its conflict of laws principles providing for the application of the laws of any other jurisdiction.

Introduction



TA-SCOPE is a tough, effective balancing instrument for accurate measuring and documenting of differential pressure (Δp), flow, temperature and power in hydronic systems.

Wireless functionality and an easy-to-use interface ensure quicker and more cost-efficient balancing and trouble shooting.

TA-SCOPE links effortlessly to the PC software – HySelect – gaining the maximum benefit from recorded data and enabling professional report writing and automatic software upgrades.

TA-SCOPE consists of two main components:

Handheld unit – computer based unit programmed with the TA valve characteristics. Straightforward functions with easy-to-follow instructions on the color display.

Differential Pressure Sensor unit – the DpS-Visio communicates wirelessly with the Handheld and has an OLED display for showing its status, measured data and other information.

Instrument and Measuring Equipment

- 1 Handheld unit (Hh)
- 2 Dp Sensor unit (DpS-Visio)
- 3 Digital Temperature Sensor (DTS)
- 4 Measuring hoses, 20 in., red/blue
- 5 Safety pressure and temperature probe (SPTP)
- 6 Safety pressure probes (SPP)
- 7 Measuring hoses with twin needle, 6 in.
- 8 Flashlight
- 9 Mirror
- 10 Chucks for older valves, red/blue
- 11 Allen Keys 3 mm/5 mm
- 12 Spanner for measuring points on older valves
- 13 Presetting tool TBV-C, -CM, (-CMP)
- 14 Grip tool for setting wheel
TA-COMPACT-P/-DP and TA-Modulator
(DN 15-32)
- 15 Spare filters and O-rings for hoses
(4 pcs)
- 16 Chain for mounting
- 17 Neckstrap
- 18 Multi-charger for Handheld and
Dp Sensor(s) (EU, UK, US, AU/NZ)
- 19 USB cable for charging;
Hh - Multi-charger
- 20 USB cable for connection/charging;
Hh - DpS-Visio /
PC - DpS-Visio /
DpS-Visio - Multi-charger
- 21 USB cable for connection;
Hh - PC
- 22 Cable wrapping
- 23 Case
- 24 USB stick with manual and HySelect
software
- 25 Calibration certificates for DpS-Visio,
DTS and SPTP
- 26 Quick Guide
- 27 SPTP/SPP stickers
- 28 TA-SCOPE Portal / Guarantee/Service/
Calibration form

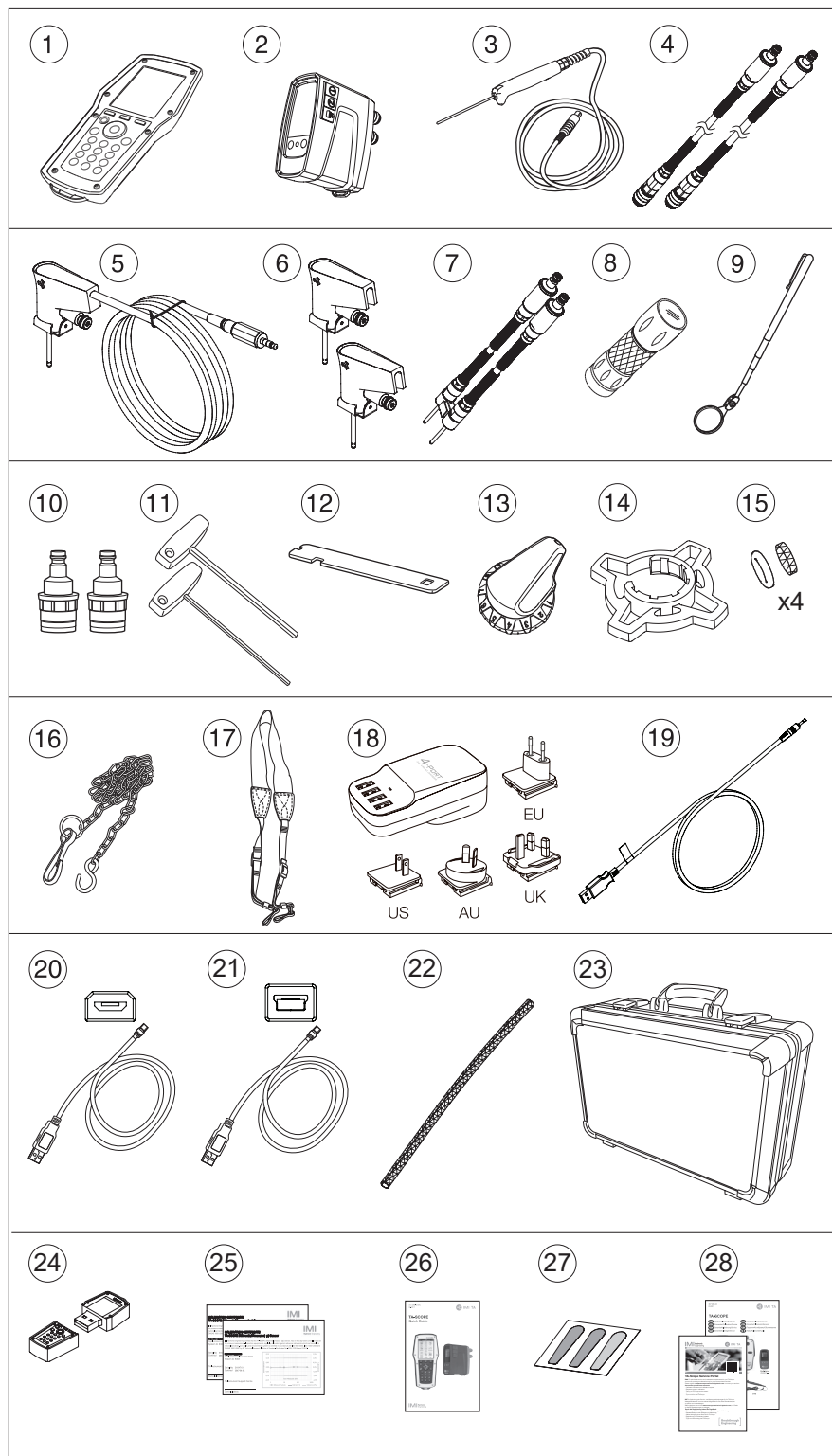

Guide to Manual and Instrument

General Instrument Instructions

TA-SCOPE facilitates effortless performance of all hydronic functions through easy to navigate menus.

Handheld

The display is divided into three areas, the Information bar, the Main display and the Function keys.



1 – Information bar

Icons on the Information bar display details of battery status, connection type and intensity.

2 – Main display

Instructions on how to carry out hydronic functions are shown on the Main display.

3 – Function keys

The three top keys on the key board are used for selecting options shown in the lower part of the Main display. The options vary depending on which menu is currently shown.

Keypad

- The keypad has alphanumeric keys. Select a letter by repeatedly pressing the key until the desired letter appears. Prolonged press enters a digit.
- Dot key works as caps lock. For a dot keep the key pressed until a dot appears.
- The zero key works as a space bar.

Entering Information in Menus

- When entering values to an input field in a menu, navigate $\blacktriangle\blacktriangledown$ to the desired row and start typing.
- Cycle $\blacktriangleleft\blacktriangleright$ the options in the input fields.
- Change units from the menu for any of the hydronic functions by navigating $\blacktriangle\blacktriangledown$ to the desired row and cycle $\blacktriangleleft\blacktriangleright$ the units.
- Increase/decrease values like valve size, time, date direct from the input field by cycling $\blacktriangleleft\blacktriangleright$ the options.
- To prevent entering a too high or too low value TA-SCOPE automatically corrects values in the input fields. The maximum/minimum value will appear in red, accompanied by a beep.



Tips! The numbers 1-9 can be used to shortcut the menus in the main display.

Special Menu Features



If multiple temperature sensors are connected when measuring, cycle the sensors by navigating $\blacktriangle\blacktriangledown$ to the temperature row and press enter. An icon on the display indicates which of the sensor is currently showing temperature reading.

The temperature to be considered for fluid properties can be taken either from one of the connected temperature sensors or from direct input in the fluid screen. Navigate $\blacktriangle\blacktriangledown$ to the icon beside the fluid field and press enter to cycle amongst the available options.

Abbreviations

Hh	Handheld unit
DpS-Visio	Differential Pressure Sensor unit
DTS	Digital Temperature Sensor
SPTP	Safety Pressure and Temperature Probe
SPP	Safety Pressure Probe
Dp / Δ p	Differential Pressure
DT / Δ T	Differential Temperature
q	Flow
P	Power
T	Temperature

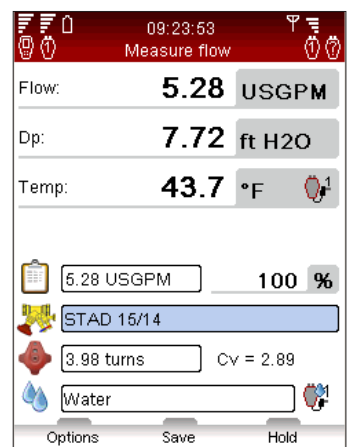

Display and Keypad

Handheld

Display



Information Bar Icons

	Battery status bar
	Charging of battery
	Battery symbol
	Handheld
	Dp sensor DpS-Visio
	Dp sensor (older version)
	Wireless communication
	Intensity of wireless signal
	Wireless signal set to Off
	Connection by cable

Keypad



Keypad Icons

	Function key <i>Options depend on text in display</i>
	On/Off
	Flow adjustment (Computer method) <i>Short cut button</i>
	Return/Escape
	Enter
	Navigation up/down
	Navigation right/left
	Alphanumeric <i>0-9, A-Z plus symbols</i>

Functional Contents

	Quick Measure <i>Page 18</i>	Measure Flow Measure Differential Pressure (Δp) Measure Temperature Measure Power View Saved Measurements
	Hydronic Networks <i>Page 23</i>	Navigate Hydronic Networks Add New Network Edit Network Delete Network Measure, Balance & Log Functionality
	Balancing <i>Page 25</i>	Prerequisites for Balancing Balance a Hydronic Network with TA-Diagnostic Balance a Hydronic Network with TA-Wireless Modify or Define New Module
	Troubleshooting <i>Page 29</i>	Diagnose a Hydronic Network with TA-Diagnostic Use the Required Dp on Circuit Troubleshooting Wizard
	Data Logging <i>Page 30</i>	Set Parameters for Logging Perform Logging Download logging from Dp Sensor View Loggings in Handheld Display Logging as Graph/List
	Fluid <i>Page 34</i>	Fluid Type Temperature Select Additive Additive Concentration Define Other Fluid
	Hydronic Calculator <i>Page 35</i>	Calculate Flow-Cv-Dp Calculate Power-Flow-DT Calculate Valve setting Select Pipe / Valve Conversion of Units
	Settings <i>Page 37</i>	Instrument Setup Wireless Signal Language Power Saving
	Information <i>Page 39</i>	Instrument Information Software Version Battery Capacity

DpS-Visio

The display is divided into three areas, the Information bar, the Main display and the Function keys.

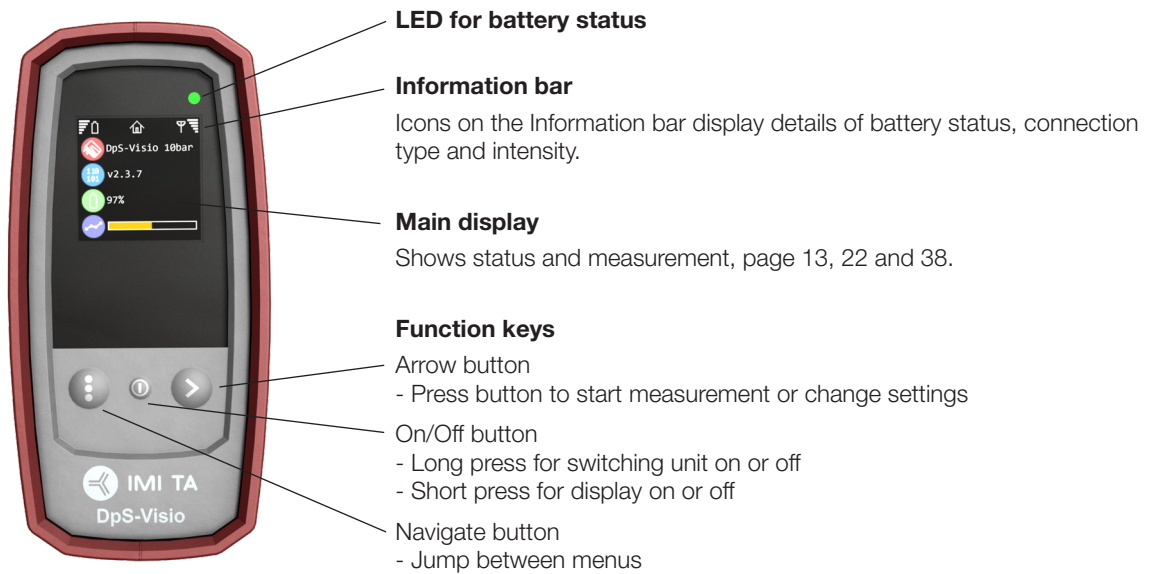

Note! Never leave water in the Dp Sensor unit when risk of freezing exists (i.e., in the car during winter).

DpS-Visio – Main screen sequences

**Navigate button**

Short press: Browse between menus described here.
 Long press: Entering setting menu. See page 38.

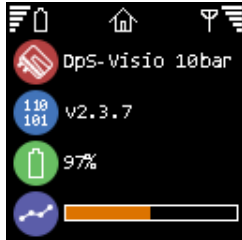
**Home**

DpS-Visio type (5 or 10 bar)

Software version number

Battery level

Logging progress (Replaced by  when a logging is waiting to start)

**Logging**

Logging progress (Replaced by  when a logging is waiting to start)

Progress in time versus Total logging time

Time-step

Last logged values

**Info**

Software version number

Wireless software version number

Serial number

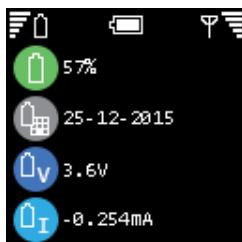
**Battery**

Battery level

Battery installation date

Battery voltage

Battery current (+ when charging)

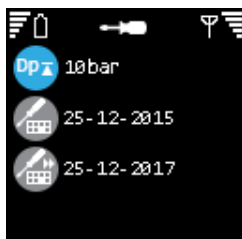
**Calibration**

Dp range

Date of last factory calibration

Date of next recommended factory calibration

Measuring Preparations

Prerequisites for Balancing with TA-SCOPE

TA-SCOPE is one of the components in the powerful TA methodology for balancing of hydronic systems.

The ultimate goal of every heating and cooling installation is to provide the desired indoor climate at the lowest possible energy cost. This requires a fully controllable hydronic system. Achieving full hydronic control depends on meeting three key conditions:

- Design flow must be available at all terminals.
- Differential pressure (Δp) across control valves must not vary too much.
- Flows must be compatible at system interfaces.

The best way to attain these conditions is to perform a balancing procedure using TA-SCOPE. Balancing ensures that the plant actually performs as specified by the designer and operates the way the designer intended.

Switch on/off the units

The Handheld and Dp Sensor units are switched on and off individually.

The Handheld Information bar displays details on intensity of wireless signal and battery status for the connected units.

Handheld

Press  on the keypad during 1 second to switch on/off.

Dp Sensor

Press  during 1 second to switch on/off.

Sleep Mode

Once the screen has dimmed and been set to sleep mode the Handheld unit is still active, touch any key to return directly to the last screen used.

If a unit is switched off whilst in sleep mode and then started again the start position is the main menu and previous actions are interrupted.

If a Dp Sensor is actively performing a logging function, it will automatically go into sleep mode after 15 minutes. The logging process will then continue whilst in sleep mode.

If a Dp Sensor is not actively performing a logging function, the unit will automatically switch off if it does not detect its paired handheld within 30 minutes.

Adjustments of display settings and sleep mode are performed in the **Settings** menu, see page 37.



Wireless Communication

On delivery TA-SCOPE is prepared for wireless communication.

No adjustments of settings or other actions are required.

If required the Handheld and Dp Sensor units can be connected via cable.

Wireless communication uses radio frequency and is therefore not allowed in areas where other vital electronic devices can be disturbed, i.e., near medical equipment and implanted cardiac pacemakers, in health care facilities, aircrafts, blasting areas, areas with potentially explosive atmospheres and other areas posted "turn off two-way radio".

Cut the wireless connection from the **Settings** menu.  is displayed on the antenna icon  in the Information bar and the antenna LED of the Dp Sensor stops flashing.

When reactivating the wireless function the units should initially be connected with the cable to establish radio communication. If wireless communication stops due to the units being out of radio range, they will automatically reconnect when back within radio range as long as the **Wireless Signal** option is set to **On**.

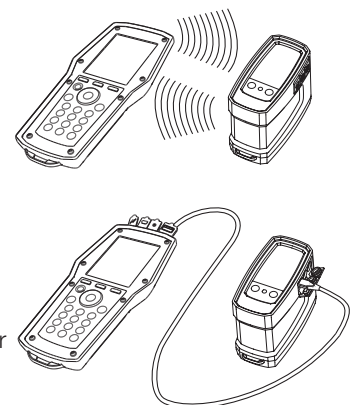

Connect Alternative Dp Sensor

Any Handheld and Dp Sensor can become a wireless pair. This may be particularly useful in companies with several TA-SCOPE instruments. Establish communication between your Handheld unit and the Dp Sensor you currently wish to work with.

- 1 Connect the units with the cable and check that wireless option in Settings menu is set to On.
- 2 Wait until the wireless icon  is displayed on the Information bar.
- 3 Disconnect the cable and wireless communication is established.



Tips! Wireless range Handheld – Dp Sensor. Range in open space – approximately 230 ft (70 meters). Range inside a building – approx. 65-98 ft (20-30 meters).

Connect / Disconnect Measuring Equipment

The measuring equipment is color coded to ensure valid data is collected, red indicates high pressure and blue indicates low pressure.



Warning! Beware of hot fluid in the valve. Always follow the sequence described here when connecting and disconnecting the measuring equipment.

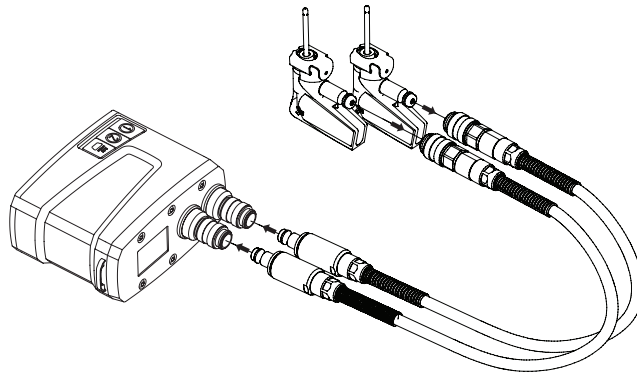

First – connect the Safety Pressure Probes (SPP) to the measuring hoses which shall be connected to the Dp Sensor, pay attention to the color indications.



Note! When using the combined Safety Pressure and Temperature Probe (SPTP), do not forget to connect the data cable to one of the two temperature probe connections on the Dp Sensor.

Second – connect the Safety Pressure Probes to the measuring points on the valve, which are also color coded.

Make sure the safety catches lock behind the thread on the measuring point.

When disconnecting, press the safety catches at the Safety Pressure Probe and pull to release.



Warning! The surface on the Dp Sensor can be hot while measuring on hot media. Always use suitable safety equipment.

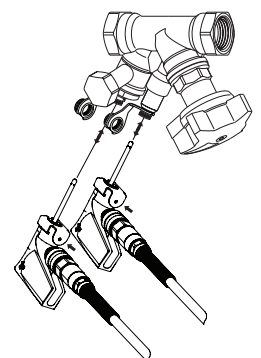

Each hydronic function in TA-SCOPE requires a specific set-up of measuring hoses and temperature sensors.

On screen diagrams will be displayed on the Handheld for guidance.

The Dp Sensor can either be hung by the hoses or by the accessory (15) chain in the pipes.

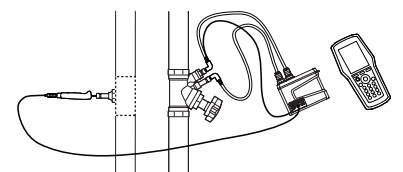

Calibration of Dp Sensor

To achieve correct measuring values calibration of the Dp Sensor is always required prior to measurements of flow and differential pressure (Δp).

Air pockets might be left in the hoses and these are vented through calibration to maintain optimal accuracy.

TA-SCOPE automatically performs calibration when needed.

Handwheel

Each TA balancing valve has a handwheel for determining valve opening. The digital read out displays the number of turns.

In the picture on the side, the valve to the left is completely shut and displays 0.0 and the valve to the right is open by 2.3 turns.

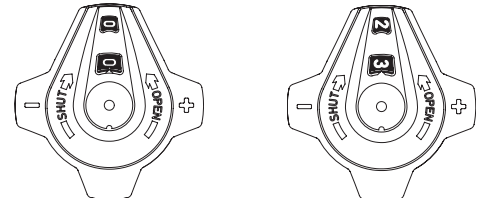

Connections for Cables

Handheld connections

- 1 Charger
- 2 USB to PC
- 3 Temperature probe (SPTP or DTS)
- 4 USB to Dp Sensor



Dp Sensor Connections

- 1 Temperature probe 1 (SPTP or DTS)
- 2 Temperature probe 2 (SPTP or DTS)
- 3 Charger and USB to Handheld

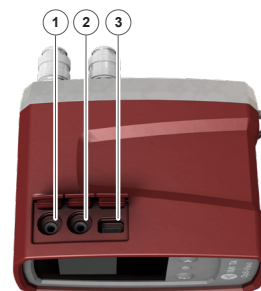

Hydronic Functions

Overview of Hydronic Functions

TA-SCOPE enables various alternatives for exploring and diagnosing hydronic systems. On screen diagrams will guide you through the physical set up of the measurement equipment as required for the hydronic function you would like to perform.

The hydronic functions then enable the system data to be used effortlessly in many flexible and useful ways.

The main hydronic functions of TA-SCOPE, where system data can be collected and applied, are as follows:



Quick Measure – Straightforward function to measure flow, differential pressure (Δp), temperature and power. To be used when only one or a few valves are of interest. The function does not require any predefinition of network or module.



Hydronic Networks – Complex networks created in HySelect are easily downloaded to TA-SCOPE. Use a network for measuring and balancing at any time; during commission, for control and inspection. All hydronic functions can be applied to a selected valve from a Hydronic Network.



Balancing – The powerful TA-Wireless and TA-Diagnostic methods for balancing hydronic systems. TA-Wireless makes use of two Dp Sensors with wireless technology to easily perform balancing of a hydronic module. With TA-Diagnostic, you measure all valves in a module. The method calculates a Dp diagnostic for the module and correct valve openings to attain design flows.



Troubleshooting – Software wizards take you step-by-step through the process of locating and diagnosing problems and errors in hydronic systems, e.g., Dp (Δp) analysis.



Data Logging – Measurement during a predetermined period of time to analyse any fluctuations in flow, differential pressure (Δp), temperature and power. The logged data is stored and listed or displayed as a graph, both in TA-SCOPE and HySelect.

Quick Measure





Explanation of Function



Use Quick Measure for measuring flow, differential pressure (Δp) and temperature in a waterborne heating/cooling system. The function also provides a measuring method for estimating power.

Quick Measure is the preferred method for separate measurements on a few selected valves. For example when performing control or inspection of a balanced system.

Measure Flow

- 1 Connect measuring equipment depending on desired measurement. The **Measure Flow** function enables a combined measurement of differential pressure (Δp), flow and temperature. More connecting details on page 15.
- 2 Navigate $\blacktriangle\blacktriangledown$ to **Quick Measure** in the main menu and press enter.
- 3 Navigate $\blacktriangle\blacktriangledown$ to **Measure Flow** and press enter.
- 4 Optionally input **Design Flow**. Navigate $\blacktriangle\blacktriangledown$ to  and type the given design flow for the terminal. While measuring the deviation is given in percent besides the entered design flow.
- 5 **Define valve**. Navigate $\blacktriangle\blacktriangledown$ to  and press enter.
- 6 Select input field for **Type** and press enter.
- 7 Navigate $\blacktriangle\blacktriangledown$ to desired valve type and press enter.
- 8 Continue by defining **Family** and **Valve** in the same way.
- 9 Make valve settings valid by pressing the function key **Done**. Valve settings are visible in the **Measure Flow** menu. Valve size can easily be changed from here, navigate $\blacktriangle\blacktriangledown$ to  and cycle $\blacktriangle\blacktriangleright$ the options. Type and family stays the same.
- 10 Input **Valve Opening**. Navigate $\blacktriangle\blacktriangledown$ to  and type the number of turns stated at the digital read-out at the handwheel, more handwheel details on page 16.
- 11 Define fluid in . Press enter and navigate $\blacktriangle\blacktriangledown$ to input fluid temperature and properties. Press enter.
- 12 Freezing point is stated below the temperature input field and the auto correction function indicates if the allowed limits are exceeded. More **Fluid** details on page 34.
- 13 Press function key **Done** to make fluid definition valid.

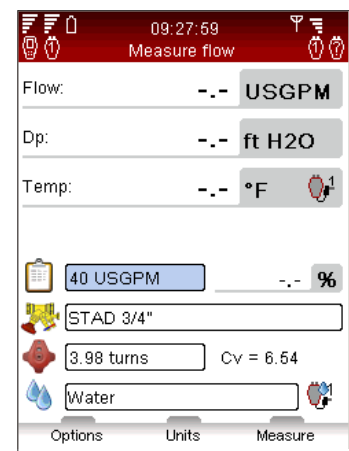
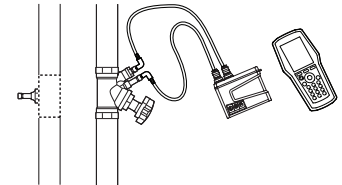

Note! Remember to always update fluid properties according to the system currently being measured.

- 14 Press function key **Measure** to start measuring.
- 15 After the calibration cycle is done the measurement begins and values are displayed for Differential Pressure (Δp), Flow and optional Temperature if the temperature sensor(s) is connected.
- 16 If multiple temperature sensors are connected, cycle the sensors by navigating $\blacktriangle\blacktriangledown$ to the temperature row and press enter. An icon  indicates which of the sensors is currently showing a temperature reading.



Tips! Short cut to increase/decrease valve size and valve turns from the measuring menu – press $\blacktriangle\blacktriangleright$ when the input field is in focus.

- 17 Press function key **Hold** to pause the measuring, and press **Continue** to resume.

18 Save measurements

- Press function key **Save** to store the measured data for future needs.
- Enter a name for performed measurement. Date and time is automatically added.
- If the name entered is already used, an overwrite request is displayed.
- Optionally enter a description.
- Press function key **Save**, the measurement is saved and measuring menu appears again.

- 19 End measurement by exiting the menu, press $\blacktriangle\blacktriangleright$ and disconnect the measuring points according to page 15.

View Saved Measurements

- 1 Select **View Saved Measurements** from the **Quick Measurements** main menu, press enter.
- 2 Measurements are displayed in a list showing reference i.e., the entered name, type of measurement and date/time.
- 3 Press function key **View** to open up details on the measurement in focus.
- 4 Delete measurements one by one using the function key **Delete**.
- 5 Delete all saved measurements from the function key **Options** and navigate $\blacktriangle\blacktriangledown$ to **Delete all quick measurements**, press enter.

Flow Adjustment – Computer Method

TA-SCOPE enables a method for correcting the flow to attain desired flow for terminals with a given design flow. TA-SCOPE will lead you through the process.

- 1 Whilst measuring on a valve press = or function key **Option** and navigate $\blacktriangle\blacktriangledown$ to **Flow Adjustment (Computer Method)**, press enter.
- 2 Shut the valve and press function key **Done**.
- 3 Measurement will continue and display differential pressure (Δp) for the closed valve.
- 4 TA-SCOPE automatically calculates a new handwheel position in order to attain design flow.
- 5 Adjust handwheel accordingly and press function key **Recalculate**.
- 6 If needed, perform further calculations and handwheel adjustments to reach the desired flow.
- 7 Finish the adjustment by pressing function key **Quit**.

Cv-mode for non-TA valves

TA-SCOPE is supplied containing an up-to-date database of TA valves. However measurements on non-TA valves are also possible. Instead of selecting a TA valve the Cv-value can be used.



- 1 Press function key **Options**, navigate $\blacktriangle\blacktriangledown$ to **Switch to Cv-mode**, press enter.
- 2 Cv icon is shown instead of = and the valve properties can not be adjusted.
- 3 Once in Cv-mode, quick measurement operations are continued in Cv-mode until you switch back to TA valve mode.

Change Units

Default units in TA-SCOPE are automatically preset according to your market. However all units can be changed depending on your personal preferences.

- 1 Press function key **Units** to change any of the units.
- 2 Navigate $\blacktriangle\blacktriangledown$ up and down in the list.
- 3 Cycle the alternatives $\blacktriangleleft\blacktriangleright$ or press enter to display the alternatives and enter to select.
- 4 The function key **Reset** will bring back the default unit for the one in focus.
- 5 Press function key **Reset all** to set the default units for all parameters.
- 6 Return to measuring menu by pressing function key **Quit** or = from the keypad.



Tips! Easily change units directly from the measuring menu – navigate $\blacktriangle\blacktriangledown$ to the measurement row e.g., Flow and press $\blacktriangleleft\blacktriangleright$ repeatedly to cycle available units.

Measure Differential Pressure (Δp)

- 1 Connect the measuring equipment according to page 15.
- 2 Navigate $\blacktriangle\blacktriangledown$ to **Quick Measure** in the main menu and press enter.
- 3 Navigate $\blacktriangle\blacktriangledown$ to **Measure Dp** and press enter.
- 4 After the calibration cycle is done the measurement begins and the Differential Pressure (Δp) is displayed.
- 5 It is possible to save measured data, see item 18 (page 18) in the **Measure flow** section.
- 6 End measurement by exiting the menu, press \curvearrowright and disconnect the measuring points according to page 15.

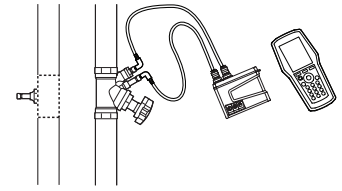

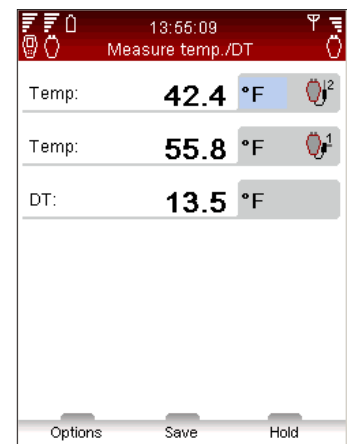
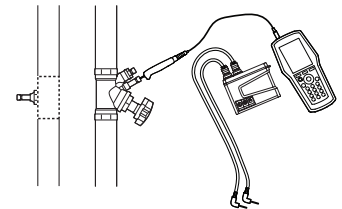
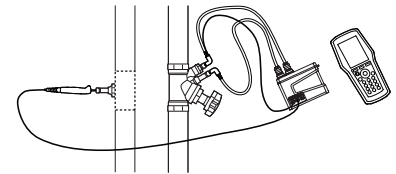

**Measure Temperature**

- TA-SCOPE enables three ways to connect the temperature sensors. The Dp Sensor has two connections and Handheld one. The icons to the left indicates for each row on the display which sensor the data comes from.
- 1 Connect the required temperature sensors.
 - 2 Navigate $\blacktriangle\blacktriangledown$ to Quick Measure in the main menu and press enter.
 - 3 Navigate $\blacktriangle\blacktriangledown$ to **Measure Temperature** and press enter.
 - 4 The temperature sensor(s) begins to measure directly.
 - 5 If two sensors are measuring, the temperature difference – DT (ΔT) is displayed. DT (ΔT) can optionally be set as hidden. Press function key **Options**.
 - 6 Possible to save measuring data, see item 18 (page 18) in the **Measure Flow** section.
 - 7 End measurement by exiting the menu, press \curvearrowright and disconnect the temperature sensors from the test points.



Measure Power

TA-SCOPE contains a method for measuring power. Depending on the type of circuit, i.e., number of measuring points available, the function is performed in various ways. Follow the detailed instructions on the display.

- 1 Navigate **▲▼** to **Quick Measure** in the main menu and press enter.
- 2 Navigate **▲▼** to **Measure Power** and press enter.
- 3 **Meas. configuration** – State available measuring equipment.
- 4 State number of available measuring points. Connect the measuring needles and sensor(s), see page 15.
- 5 TA-SCOPE automatically checks if the correct set of sensors are connected according to selected measurement configuration.
- 6 If power measurement can be performed at once follow the instructions below. An alternative instruction will be displayed if not enough temperature probes or measuring points are available for measuring power in one step.
- 7 Optionally input **Design Flow**. Navigate **▲▼** to  and type the given design flow for the terminal. While measuring the deviation is given as a percentage besides the entered design flow.
- 8 **Define valve**. Navigate **▲▼** to  and press enter.
- 9 Select input field for **Type** and press enter.
- 10 Navigate **▲▼** to desired valve type and press enter.
- 11 Continue by defining **Family** and **Valve** in the same way.
- 12 Make valve settings valid by pressing the function key **Done**. Valve settings are visible in the **Measure Flow** menu. Valve size can easily be changed from here, navigate **▲▼** to  and cycle **◀ ▶** the options. Type and family stays the same.
- 13 Input **Valve Opening**. Navigate **▲▼** to  and type the number of turns stated at the digital read-out at the handwheel, more handwheel details on page 16.
- 14 Define fluid in . Press enter and navigate **▲▼** to input fluid temperature and properties. Press enter.
- 15 Freezing point is stated below the temperature input field and the auto correction function indicates if the allowed limits are exceeded. More **Fluid** details on page 34.
- 16 Press function key **Done** to make fluid definition valid.
- 17 Press function key **Measure** to start measuring.
- 18 After the calibration cycle is done the measurement begins and values are displayed for Power, Flow and Differential Temperature ΔT .
- 19 Press function key **Hold** to pause the measuring, and press **Continue** to resume.
- 20 Possible to save measuring data in the same way as Flow, see item 18 (page 18) in the **Measure flow** section.
- 21 End measurement by exiting the menu, press **↶** and disconnect the measuring points according to page 15.





DpS-Visio

Measure differential pressure and temperature with calibration



Short press or long* press

*) Keeping  pressed from the start keeps the calibration sequence in flushing phase. Flushing phase is ended by releasing 



By-pass valve opening

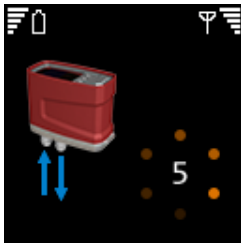

Flushing and calibration



By-pass valve closing

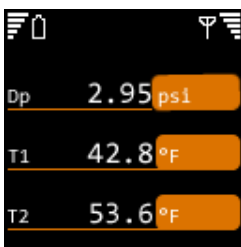

Measurement



Brings back to main screen sequence

Measure differential pressure and temperature without calibration



Double press

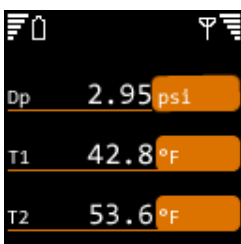

Measurement without flushing and calibration



Brings back to main screen sequence

Hydronic Networks

Explanation of Function



Hydronic systems are easily created and managed in HySelect and then downloaded to TA-SCOPE, see page 40.

Hydronic Networks is the function where hydronic systems can be explored and used for all TA-SCOPE options: Quick Measure, Balancing, Troubleshooting and Data Logging.

New networks can be created with this function. After taking actual measurements on the hydronic network, these together with the updated network design and layout, can be uploaded to HySelect.

Both networks designed for manual balancing and balancing with Dp control are manageable in the Hydronic Networks function.

Navigate Hydronic Networks

- 1 Select **Hydronic Networks** from the main menu.
- 2 Networks stored in Hh memory are displayed in a list. If no network has been created or downloaded **No Hydronic Network** is displayed.
- 3 Additional information is shown for the network in focus at the bottom part of the display.
- 4 Select a network and press enter or press function key **Navigate** to open.
- 5 Explore the network . Press or enter to expand/collapse the structure of non-terminal circuits and terminal with circuits .



Tips! Levels in a Hydronic Network *A and *A.1 are non-terminal circuits. Possible to add both terminal and non-terminal circuits to this level *A.1.1 are terminal circuits. No circuits can be added

- 6 Press function key **Options** to select the measuring type to perform. E.g., **Measure** will start a **Quick Measure** operation, select **Balance** for performing balancing of the network and **Log Data** to use the network for a logging.

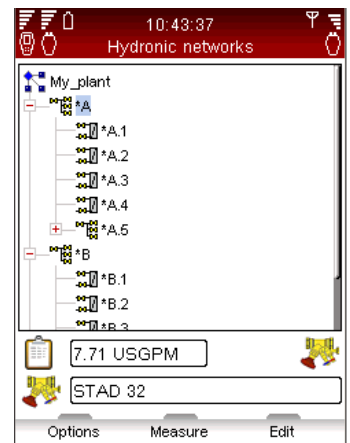
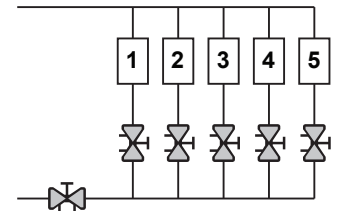

Edit Existing Network

Hydronic Networks can be modified in TA-SCOPE where changes from the original design are discovered while on site.

Depending on which level of the network is in focus, several different options can be performed.

- 1 Navigate to the circuit to be modified.
- 2 Press function key **Options**.
- 3 From here the edit options **Add circuit**, **Cut**, **Copy**, **Paste** and **Delete** are accessible.
- 4 **Add circuit** can only be performed from the top level of the network and from any non-terminal circuit.
- 5 Select **Add circuit** from the Options menu. Define if the new circuit is a terminal or non-terminal circuit.
- 6 TA-SCOPE enables several balancing options for the circuits. Navigate to the **Balancing With** drop down list and press enter. Scroll the list and press enter to select. Contact your local IMI Hydronic Engineering sales office for more details on hydronic systems with Dp control.
- 7 Press the function key **Continue**.
- 8 **Define Valve** for the circuit. Valve type and size from previous input is default, cycle the sizes with or press enter to open **Define valve** menu.
- 9 For terminal circuits **Design flow** can be entered (optional).
- 10 Enter number of circuits to add to duplicate the same circuit several times.
- 11 Press function key **Add**.





Delete Network

It is possible to delete the entire network from the **Hydronic Network** main menu.

- 1 Navigate **▲▼** to the network to be deleted.
- 2 Press function key **Options**.
- 3 Select **Delete** and press enter.
- 4 Press function key **Yes** and the network disappears from the list.
- 5 To delete individual circuits in a network, navigate **▲▼** to each circuit and delete one by one.
- 6 Open the network and navigate **▲▼** to the circuit.
- 7 Press function key **Options** and select Delete.

Create a Hydronic Network

Is also possible to create a network directly in the TA-SCOPE if no Hydronic Network has been downloaded from HySelect.

- 1 Press function key **New** from the **Hydronic Network** main menu.
- 2 Enter network name and optional description. Dot key works as caps lock. For a dot keep the key pressed until a dot appears. Numerical keys works the same, a prolonged press enters a digit.
- 3 If needed, edit the fluid settings. Navigate **▲▼** to  and press enter, more **Fluid** details on page 34.
- 4 Press function key **Create** and the new network appears in the list displayed at **Hydronic Networks** main menu.
- 5 Select **▲▼** the new network and press enter.
- 6 Add content to the network. Press function key **Options** and select **▲▼ Add circuit**, press enter.
- 7 Tick the box for **Circuit with terminal units** by pressing enter if there is a terminal.
- 8 TA-SCOPE enables several balancing options for the circuits. Navigate **▲▼** to the **Balancing With** drop down list and press enter. Scroll the list **▲▼** and press enter to select. Contact your local IMI Hydronic Engineering sales office for more details on hydronic systems with Dp controller.
- 9 Press the function key **Continue**.
- 10 **Define Valve**  for the circuit. Valve type and size from previous input is default, cycle the sizes with **◀ ▶** or press enter to open **Define valve** menu.
- 11 For terminal circuits **Design flow**  can be entered (optional).
- 12 Enter number of circuits to add.
- 13 Press function key **Add**.



Balancing

Explanation of Function



Balancing is one of the main functions in TA-SCOPE. It is a systematic methodology to ensure that the hydronic system actually performs as specified by the designer and provides the desired indoor climate at the lowest possibly energy cost.

The TA-Diagnostic and TA-Wireless methods provide a survey of the entire hydronic system and take you valve by valve, module by module through the plant. Easy-to-follow step-by-step instructions are displayed on TA-SCOPE.

Balancing can be performed both in Hydronic Networks created and downloaded from HySelect and also on modules defined on site with your TA-SCOPE.

Prerequisites for Balancing

There are several important system requirements which should be ensured before starting the balancing process.

- Variable speed pump is at full speed (set-point will be optimized after balancing).
- Control valves are fully open.
- Partner valve is fully open.
- Balancing valves of the module are all set at half-opening or at calculated presetting opening (optional for TA-Wireless method).
- The right media/fluid temperature in cooling system.

Balance a Hydronic Network with TA-Diagnostic

The TA-Diagnostic method is an evolution of the TA Balance method. The TA-Diagnostic method provides automatic calculation of valve handwheel settings module by module for the entire hydronic system to ensure design flow is available at all terminal units. It also delivers a Dp map for locating and diagnosing problems in hydronic modules.

When balancing a predefined hydronic network the action can be started either from the **Balancing** function, as described below, or directly from the function **Hydronic Networks**, see page 23. The method and required actions are then the same.

- 1 Select **▲▼ Balancing** from the main menu, press enter.
- 2 If required, adjust the acceptable flow deviations in design conditions with **Balancing Tolerance** (also available in **Settings** menu, see page 37).
- 3 Select **TA-Diagnostic method**. Press enter.
- 4 A general description of the TA-Diagnostic method is displayed. Press function key **Continue**.
- 5 A drop-down list of networks stored in your TA-SCOPE is displayed. Navigate **▲▼** to desired network and press enter. If no Hydronic Network is stored the only available option is **New Hydronic Network**.
- 6 Select **An existing module**, press enter.
- 7 The selected network appears on the display. Expand **◀ ▶** the network and navigate **▲▼** to the module where the balancing should start from.
- 8 Ensure the essential balancing prerequisites displayed in the list are fulfilled, press function key **Continue**.
- 9 A list of options appears on the display. Select **Perform Balancing** and press enter.
- 10 The selected module appears on the display. Navigate **▲▼** to the first valve you wish to measure on and press enter.

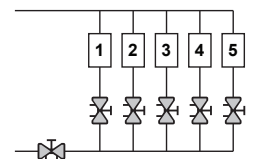
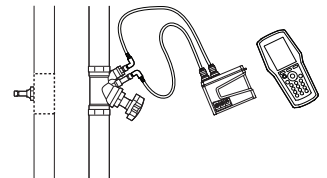

Tips! In the TA-Diagnostic method valves can be measured in any order but numbering must follow the correct order starting at 1 at the entry of the module and incrementing by 1 for each next valve as we progress towards the end of the module.

- 11 Connect the measuring equipment to the first valve you wish to measure on, see page 15 for connection details.
- 12 System properties including design flow, valve type and valve opening for the selected valve are displayed.
- 13 Press the function key **Measure**.

- 14 After the calibration cycle is done the measurement begins and values for the connected valve are displayed.
- 15 Press function key **Continue**.
- 16 Shut the valve and then press the function key **Done**.
- 17 Values for the closed valve are displayed. Press function key **Continue**.
- 18 Re-open the valve to the previous setting as displayed and press function key **Continue**.
- 19 The selected module appears on the display. Navigate **▲▼** to the next valve you wish to measure. Press function key **Measure** and repeat the process from item 11.
- 20 Continue to measure all valves in the module until they are all marked with a green tick. Follow the sequence as above and instructions on the display. To check current status of the valves in the module press **View measured data** from the **Options** menu.
- 21 When all valves in the chosen module are measured select **Calculate** from the **Options** menu.
- 22 A table of diagnosed Differential Pressures (Dp) in the module is displayed on screen. The diagnosed Differential Pressures correspond to the pressure drops that will happen in each circuit and distribution pipe segment (supply+return) when design flows will be obtained in all circuits.
- 23 Navigate **▲▼** in the diagnostic table to compare the diagnosed values to the design Differential Pressures (Dp) if you have downloaded a calculated hydronic network from HySelect. Press function key **Continue**.
- 24 Calculated setting for each valve in the module are shown in a list, adjust the valves accordingly.
- 25 Repeat the balancing process as above (item 6-24) for each module in the Hydronic Network.
- 26 To verify the completeness of the balancing process a control measurement of each valve should be performed.
- 27 The collected data from the control measurement can be uploaded to HySelect and used for a Balancing report.

Balance a Hydronic Network with TA-Wireless

The TA-Wireless method makes use of wireless technology and simultaneous measurement with two Dp sensors for balancing a hydronic network. It minimizes the number of access to each balancing valve.

When balancing a predefined hydronic network the action can be started either from the Balancing function, as described below, or directly from the function Hydronic Networks, see page 23. The method and required actions are then the same.



Tips! Make sure that you have two Dp sensors available and that your TA-SCOPE is set in two Dp sensors mode before starting balancing with the TA-Wireless method, see Wireless signal on page 37.

- 1 Select **▲▼ Balancing** from the main menu, press enter.
- 2 If required, adjust the acceptable flow deviations in design conditions with **Balancing Tolerance** (also available in **Settings** menu, see page 37).
- 3 Select **TA-Wireless method**. Press enter.
- 4 A general description of the TA-Wireless method is displayed. Press function key **Continue**.
- 5 A drop-down list of networks stored in your TA-SCOPE is displayed. Navigate **▲▼** to desired network and press enter. If no Hydronic Network is stored the only available option is **New Hydronic Network**.
- 6 Select **An existing module**, press enter.
- 7 The selected network appears on the display. Expand **◀ ▶** the network and navigate **▲▼** to the module where the balancing should start from.
- 8 Ensure the essential balancing prerequisites displayed in the list are fulfilled, press function key **Continue**.
- 9 A list of options appears on the display. Select **Perform Balancing** and press enter.

- 10 The selected module appears on the display. A blue circle with an arrow indicates that the reference valve (the last valve) is the valve to start with. Navigate $\blacktriangle\blacktriangledown$ to the reference valve and press function key **Measure**.



Tips! The TA-Wireless method always starts by measuring on the last valve of the module with Dp sensor nr 2. This valve is named the **Reference Valve**.



Tips! Numbering of the valves in a module must follow the correct order starting at 1 at the entry of the module and incrementing by 1 for each next valve as we progress towards the end of the module.

- 11 Read the displayed instructions and connect Dp sensor nr 2 to the last valve, see page 15 for connection details. Press function key **Continue**.

- 12 After the calibration cycle is done the measurement begins and values for the last valve are displayed in the upper right side of the screen. Adjust valve setting to the value indicated on screen. This setting is calculated by TA-SCOPE to ensure balancing with minimum pressure drops. You may unlock the setting by selecting **Unlock valve setting** from the **Options** menu. Press function key **Continue**.

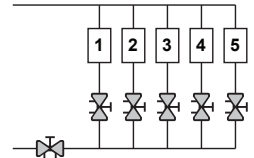

- 13 Read the displayed instructions and connect Dp sensor nr 1 to the “upstream” valve. Press function key **Continue**.

- 14 The module appears on the display. The reference valve is marked with a green tick and a blue circle with an arrow indicates that the upstream valve is the next valve to be measured. Press function key **Measure**.

- 15 After the calibration cycle is done the measurement begins. Values from the two Dp sensors are displayed side-by-side in the upper part of the screen.

- 16 Adjust and input valve setting until you equalize displayed flow ratios. Alternatively you may press function key **Adjust** which will start a computer-aided measuring process to equalize flow ratios. Press function key **Continue** when flow ratios are equalized.

- 17 The module appears on the display. The reference valve and upstream valve are marked with a green tick and a blue circle with an arrow indicates that the next valve to be measured. Press function key **Measure** and repeat the process from item 15 above.

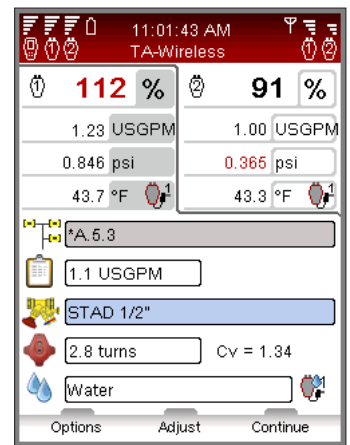

- 18 Continue to measure all valves in the module until they are all marked with a green tick. Follow the sequence as above and instructions on the display.
- 19 When all valves in the chosen module are measured and adjusted, an information screen is displayed with instructions to complete the balancing of the module. Press function key **Continue**.
- 20 Leave Dp sensors 1 and 2 in place and adjust the partner valve until flow ratios of 100% are measured by both Dp sensors. Press function key **Save**. The obtained flows in the first and last valves of the module are then saved in memory.
- 21 To verify the completeness of the balancing process a control measurement of the other valves of the module should be performed.
- 22 The collected data from the saved measurements can be uploaded to HySelect and used for a Balancing report.

Modify or Define New Module

Whilst on site and performing balancing on a hydronic system changes from the original design might be discovered. The function **A newly defined module** enables you to add modules to a hydronic network in TA-SCOPE.

- 1 Select **▲▼ Balancing** from the main menu, press enter.
- 2 If required, adjust the acceptable flow deviations in design conditions with the option **Balancing Tolerance** (also available in **Settings** menu, see page 37).
- 3 Select **TA-Diagnostic method** or **TA-Wireless method**. Press enter.
- 4 Navigate **▲▼** to **A newly defined module**, press enter.
- 5 Enter number of circuits to add to the module.
- 6 Untick the box **Partner valve available** if no partner valve is included in the module.
- 7 If required adjust the option **Minimum Dp in the index valve**, which is set by default to the market standard value.
- 8 Press function key **Continue**.
- 9 Define system properties including design flow, valve type and valve opening for the valves in the new module. Press function key **Continue**.
- 10 A list of existing hydronic networks is displayed and the newly defined module can be inserted into one of these. Navigate **▲▼** the desired network and press enter.
- 11 The network will appear as an expandable structure. Press **◀▶** or enter to expand/collapse the network. Navigate **▲▼** to the correct level for the new module, press enter to insert.
- 12 Enter a module name of your own preference or use the automatic name function by ticking the box **automatic**, press enter when the box is in focus.
- 13 Alternatively a separate network for the new module can be created. Instead of selecting an existing network, enter a network name which has not been used previously. Also name the module, either enter a name or use the automatic function.
- 14 Press function key **Continue** to start balancing the valves in the new module.
- 15 Continue the balancing process as described in “Balance a Hydronic Network with TA-Diagnostic”, item 8 (page 25) to the end, or as described in “Balance a Hydronic Network with TA-Wireless”, item 8 (page 26) to the end.

Troubleshooting

Explanation of Function



Troubleshooting is all about measuring relevant hydronic data and making use of them to deduce the origin of hydronic problems. It is a key functionality provided by TA-SCOPE.

The TA-Diagnostic method is an evolution of the well-known TA Balance method that takes you valve by valve, module by module through the plant. Easy-to-follow step-by-step instructions are displayed on TA-SCOPE. The TA-Diagnostic method delivers a Dp map for locating and diagnosing problems in each hydronic module on which it is used.

Software wizards are also available in the TA-SCOPE taking you step-by-step through the process of diagnosing problems and errors in a hydronic circuit.

Diagnose a Hydronic Network with TA-Diagnostic

The TA-Diagnostic method is a balancing and diagnostic method. It can be started either from Troubleshooting or from Balancing in the main menu, see page 25 for a detailed description. The method and required actions are the same.

Use the Required Dp on Circuit Troubleshooting Wizard

This troubleshooting wizard is to be used when design flow cannot be obtained in a circuit. Based on two measurements, it allows determining the Differential Pressure (Δp) to be applied on a circuit in order to reach the design flow. Required equipment is a flow measuring valve in the circuit that can be installed on supply or return side and one measuring point on the other side.

- 1 Select **▲▼ Troubleshooting** from the main menu. Press enter.
- 2 Select **▲▼ Required Dp on circuit**. Press enter.
- 3 Ensure the required equipment listed on screen is available on the circuit, press function key **Continue**.
- 4 Connect the Dp sensor as shown on screen. Note that you will need to adjust the valve setting in the next step in order to reach a minimum Dp usually set at 1 ft H₂O / 0.5 psi (3 kPa). Press function key **Continue**.
- 5 You are in the **Measure flow** screen. You can input design flow, change valve type and diameter, input valve setting and define the fluid. Follow steps 4 to 14 from **Measure flow** section in page 18.
- 6 After the calibration cycle is done the measurement begins and values are displayed for Differential Pressure (Δp), Flow and optional Temperature if the temperature probe(s) is connected.
- 7 Adjust and input accordingly valve opening until you obtain more than 1 ft H₂O / 0.5 psi (3 kPa). in the valve. Press function key **Continue**.
- 8 Connect the Dp sensor as instructed on screen in order to measure the current Differential Pressure (Δp) of the circuit, press function key **Continue**.
- 9 After the calibration cycle is done the measurement begins and a value is displayed for Differential Pressure (Δp). Press function key **Continue**.
- 10 Troubleshooting data are displayed. **Measured Dp on circuit** and **Measured flow** are the two measurements you have just performed. **Required Dp on circuit** is the Differential Pressure (Δp) that will be required on the circuit in order to be able to reach the design flow you have input. You can input another design flow to examine the corresponding required Differential Pressure on the circuit.

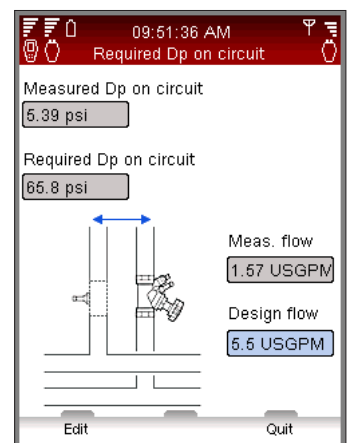
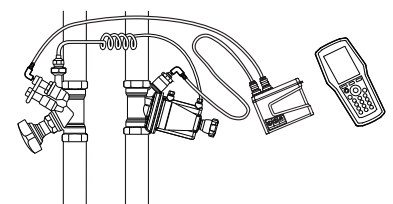
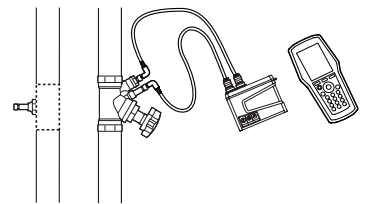

Data Logging

Explanation of Function





Data Logging is used to study fluctuations of system performance over a predetermined period of time. Flow, differential pressure (Δp), temperature and power can be logged.

Connect the Dp Sensor to the valve and then perform preparations to collect system data. During the predefined time period the Dp Sensor can be left at the site to log measurements. When the measuring period is finished the stored data is available for downloading to the Handheld.

A logging can be performed both from a valve defined in a Hydronic Network or a separate valve free of choice.

Start a New Logging

- 1 Connect measuring equipment according to the logging to be performed. For e.g., **Flow and temperature logging** the Dp Sensor and one temperature sensor is required. Connection details on page 15.
- 2 Navigate **▲▼** to **Data Logging** in the main menu, press enter.
- 3 Select **Start New Logging**, press enter.
- 4 Navigate **▲▼** to the type of measuring to be performed e.g., **Flow and temp logging**, press enter.
- 5 Available sensors, their status and connections are displayed in a list. Additional details and guidance are displayed below the list. Items not used in the logging are grey and can not be selected.
- 6 Navigate **▲▼** to required sensors and press enter to select. Repeat until all required sensors are selected.
- 7 Selected state is indicated by an icon, ,  or  in front of the sensors name in the list.
- 8 Press function key **Continue** to move on to valve settings.
- 9 When logging flow, differential pressure (Δp) or power, calibration is required.
- 10 After the calibration cycle is done enter valve and fluid preferences for the valve to be logged.
- 11 If the logging is started from Hydronic Network function, see page 23, the network row is active and the circuit name displayed.
- 12 If the valve is not linked to a hydronic network the network row will state **Undefined**.

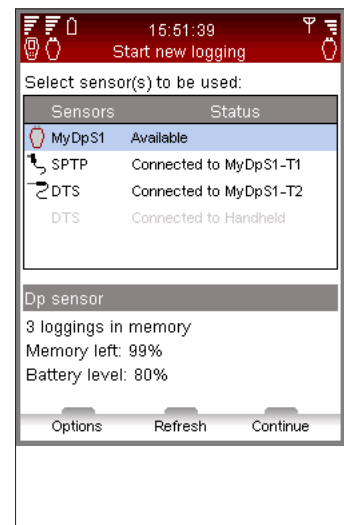
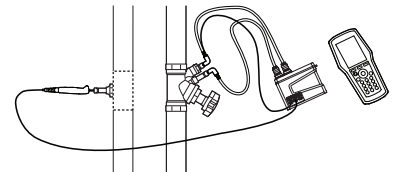

Logging Options

Type	Abbreviation	Required sensors
Flow logging	q	DpS-Visio
Dp logging	Dp (Δp)	DpS-Visio
Temperature logging	T	1 SPTP or 1 DTS <i>connected to DpS-Visio</i>
DT logging	DT (ΔT)	1 SPTP + 1 DTS (or 2 DTS) <i>connected to DpS-Visio</i>
Power logging	P	DpS-Visio & 1 SPTP + 1 DTS or DpS-Visio & 2 DTS
Flow and temp. logging	q, T	DpS-Visio & 1 SPTP or DpS-Visio & 1 DTS
Dp and temp. logging	Dp (Δp), T	DpS-Visio & 1 SPTP or DpS-Visio & 1 DTS

- 13 For non-TA valves press the function key **Option**, select **Switch to Cv-mode** and press enter. Enter information regarding the valve.
- 14 Press the function key **Continue** for further settings of the logging.
- 15 **Reference name** is by default "Log" followed by a figure which increments by the number of loggings stored. Optional; enter a reference name of your own preference.
- 16 Set **Start Date** and **Start Time** for the logging.
- 17 Set **Time Step**, in seconds, to be measured. The interval is selectable within 3 to 240 seconds.
- 18 Define **Length** of the logging which is limited by remaining memory and battery capacity of the Dp Sensor displayed on the screen.
- 19 Release memory by erasing old loggings. Press the function key **Options** and select **List loggings in memory**, press enter.
- 20 A list of loggings and the occupied memory is displayed. Press the function key **Delete** to remove the one in focus or **Delete all** for clearing the whole memory.
- 21 Press function key **Done** to return to the logging preferences.
- 22 Edit any of the parameters by pressing function key **Options** to select or navigate **▲▼** to the item, press enter and adjust the settings with **▲▼**. Press enter.
- 23 Press function key **Save** and logging will be executed accordingly to settings.
- 24 Leave Dp Sensor switched on at the valve for logging. It will automatically go into sleep mode between the measurements to minimize battery consumption.
- 25 Pick up the Dp Sensor when logging is completed.

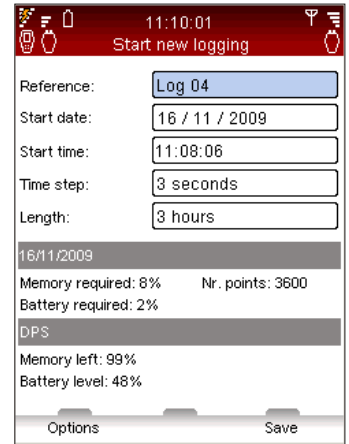

Download Loggings

When a logging is finalized the data is ready to be downloaded from Dp Sensor to Handheld for viewing and upload to PC for further analysis.

- 1 Make sure the communication, wireless or by cable, between Handheld and Dp Sensor is established.
- 2 Select **Download logging from Dp sensor** from the **Data Logging** main menu.
- 3 The status of Dp Sensor is displayed and can be;
 - **Available** – logging finished and ready to download
 - **Logging in progress** – logging is being performed
 - **Logging programmed** – Dp Sensor prepared to perform logging
- 4 Press function key **View** to display the loggings stored in Dp Sensor.
- 5 Navigate **▲▼** to the logging you wish to download.
- 6 Press function key **Download** to start. During download you can select the option to delete after completion of the download process.

View Loggings

Logged data is stored and reached with the function **View Loggings in handheld**. Possible to view data as graph or listed in several ways. Select **Data Logging** from the main menu, press enter.

- 1 Navigate **▲▼** to **View Loggings in handheld**, press enter.
- 2 Navigate **▲▼** to preferred logging, press the function key **View**.
- 3 A summary of the logging is displayed.
- 4 Press function key **Options** and select **▲▼** display alternative for the data.
 - **View logging data** – measuring points listed displayed with time and values for each one.



Tips! It is possible to download the data of a logging while this logging is in progress.

- Navigation keys $\blacktriangle\blacktriangledown$ scrolls the list page by page showing six items at the time. Press the function key **Options** for alternatives on moving to the very end or beginning of the list and also to change units for measured data.
 - **View logging graph** – measured data displayed as a graph.
 - Zoom in/out with the navigation keys $\blacktriangle\blacktriangledown$. Scroll right/left with the navigation keys $\blacktriangleleft\blacktriangleright$. Press function key **Tracking** to view logged data step by step. A vertical black line indicates the measuring point and data is displayed below the graph. Move the tracking line with $\blacktriangleleft\blacktriangleright$. Press function key **No tracking** to end.
 - **View logging statistics** – overview of the maximum and minimum measuring points for each type of data during the logged period.
- 5 Press function key **Units** to change any of the measuring units.

Logging – DpS-Visio



Logging progress (Replaced by  when a logging is waiting to start)

Progress in time / Total logging time

Time-step

Last logged values

Support Functions

Overview of Support Functions

TA-SCOPE has besides the hydronic functions also several functions to support these.



Fluid – Settings of fluid in the system to be explored and diagnosed. Water is the most common fluid in hydronic systems but water with various additives can also be handled by TA-SCOPE.



Hydronic Calculator – Perform calculations based on the relationship between flow, differential pressure (Δp), Cv-value, power and differential temperature (ΔT). The function also gives guidance in selecting pipes and valves when designing hydronic systems and enables unit conversions.



Settings – Manage adjustments regarding the instrument and appearance of information from the Settings function.



Information – Displays information like software version, last calibration and battery details on Handheld, Dp Sensor and also Temperature Sensor when connected.

Fluid

Explanation of Function





This function controls settings of fluid in the system to be measured and balanced. It is also possible to perform any adjustments of fluid from the measuring menus when entering definitions, look for the  icon.

Regardless of which menu the fluid settings are performed from, they will have impact on all present activities in TA-SCOPE at that moment.

Water is the most common fluid in hydronic systems but water with various additives can also be handled by TA-SCOPE. Automatic viscosity correction is performed for all TA valves.

Change Fluid



- 1 Select  from the main menu, press enter.
- 2 Navigate  to the second input field and expand by pressing enter.
- 3 Select  desired type of fluid by pressing enter. The most common types; glycol, brine and alcohol are selectable from the drop down list.
- 4 For the option **Any Other Fluid** the density, viscosity and specific heat are to be set. Press function key **Properties** and define the fluid.
- 5 For the fluids; Glycol, Brine and Alcohol also set the additive and the concentration as a percentage.
- 6 The top-most input field is for fluid **Temperature**. Freezing point is stated.
- 7 When finished press function key **Done**.



Tips! The auto-correction function prevents entering a too high or too low value for temperature and additive concentration.

Hydronic Calculator

Explanation of Function



Hydronic Calculator easily performs calculations based on the relationship between flow, differential pressure (Δp), Cv-value, power and differential temperature (ΔT).

This function also gives guidance in selecting pipes and valves when designing hydronic systems and enables unit conversions.

Hydronic Calculator in TA-SCOPE provides the same functionality as HyTools which originates from the Calculation Disc (Balancing Nomogram/Red disc).



Calculate Flow-Cv-Dp (Δp)





Calculate Power-Flow-DT (ΔT)





Calculate Flow-Valve Setting-Dp (Δp)

Calculate Flow/Cv/Dp (Δp)/Power/DT (ΔT)

- 1 Select **Hydronic Calculator** from the main menu, press enter.
- 2 Select calculation option:
Calculate Flow-Cv-Dp (Δp)
Calculate Power-Flow-DT (ΔT)
- 3 Chose variable to be calculated from the **Calculate** drop down list, press enter to display or cycle the list with **◀ ▶**.
- 4 Enter values for the two other variables.
- 5 Result is automatically displayed.
- 6 Switch to calculate another variable, press function key  or  or .
- 7 Return to Hydronic Calculator main menu by pressing function key **Quit**.

Calculate Valve Opening

- 1 Select **Calculate valve setting (red disk)** press enter.
- 2 Select **Setting** from the Calculate drop down list.
- 3 Enter values for flow and differential pressure (Δp).
- 4 Select valve size from the drop down list, press enter.
- 5 Define valve type from the drop down list, press enter.
- 6 Result is automatically displayed.
- 7 Switch to calculate another variable, press function key  or  or .
- 8 Return to **Hydronic Calculator** main menu by pressing function key **Quit**.

Recommend Pipe Dimension



- 1 Navigate to **Select Pipe**, press enter.
- 2 Enter **Flow**.
- 3 **Select type of pipe**, cycle the options with **◀ ▶** or press enter to open drop down list.
- 4 List of calculated pipes is automatically displayed.
- 5 The best pipe dimension is indicated by a green arrow.
- 6 Scroll the list with **▲ ▼**.
- 7 Linear pressure drop and velocity is displayed for each pipe.
- 8 Switch to **Select Valve**, press function key .
- 9 Return to **Hydronic Calculator** main menu by pressing function key **Quit**.

Recommend Valve Dimension



- 1 Navigate $\blacktriangle\blacktriangledown$ to **Select Valve**, press enter.
- 2 Enter **Flow**.
- 3 **Select valve type**, cycle the options with $\blacktriangleleft\blacktriangleright$ or press enter to open drop down list.
- 4 List of calculated valves is automatically displayed.
- 5 The best valve dimension is indicated by a green arrow.
- 6 Scroll the list with $\blacktriangle\blacktriangledown$.
- 7 List also displays two alternatives for Differential pressure (Δp) at various valve openings depending on valve type.
- 8 Switch to **Select Pipe**, press function key 📌 .
- 9 Return to **Hydronic Calculator** main menu by pressing function key **Quit**.

Unit Conversion

- 1 Navigate $\blacktriangle\blacktriangledown$ to **Unit Conversion**, press enter.
- 2 Select variable for conversion, cycle the options with $\blacktriangleleft\blacktriangleright$ or press enter to open drop down list.
- 3 Set the units according to desired conversion.
- 4 When entering a value in one of the value fields the converted value is shown in the other.
- 5 Return to **Hydronic Calculator** main menu by pressing function key **Quit**.

Settings

Explanation of Function (Handheld)



In the **Settings** menu, customized adjustments of the instrument and information representation are managed.

Wireless signal

The checkbox turns the two Dp Sensors mode **On/Off**. This mode allows the use of the new TA-Wireless balancing method performing measurements with two Dp sensors simultaneously.

Available Dp Sensors, their wireless status and MAC address are displayed in a list. Items that have been previously connected to the handheld are displayed in grey if **Show DpS archive** is selected in the **Options** menu.

If a Dp Sensor is used for the first time with the handheld, they need to be paired by connecting them by cable. See **Wireless Communication** section on page 14.

Select **Disable all radios** in the **Options** menu to turn off all radio communication. Select **Enable Hh radio** to set handheld wireless signal back to **On**. When switching the wireless signal back to On each unit must be connected by cable to re-establish contact. Once  is visible in the list, disconnect the cable to commence wireless communication.

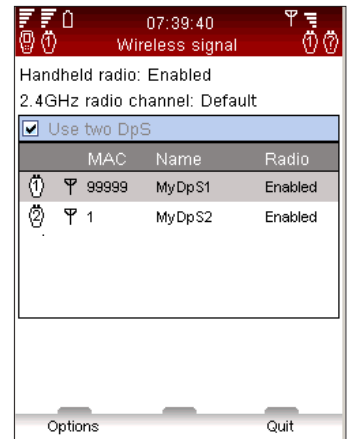

Technical Parameters

In addition to the default settings, it is possible to show a wider range of TA valves e.g., valves no longer in production. Advanced technical parameters for valves and pipes can also be customized.

Units

Displayed units are automatically set correctly for your market prior to delivery but can also be customized in this menu. It is also possible to alter the viewed units directly in the measuring menus during operation. Updated units will be maintained across the TA-SCOPE functionality. Reset All in the Units menu will bring back the market specific, standard settings

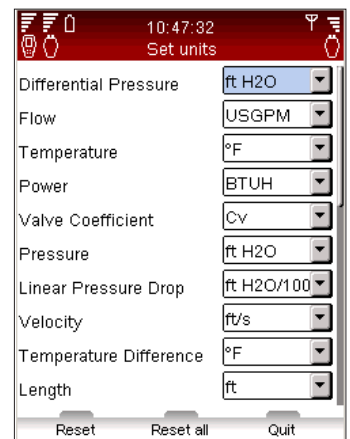

Power Saving

Adjust the display backlight intensity and time limits for screen dimming, sleep mode and switch off.

Device Names

Every Handheld and Dp Sensor can be given a customized name. This may be particularly useful in companies with several TA-SCOPE instruments. Any Handheld and Dp Sensor can become a wireless pair. Establish communication between any two units by following the process of connecting an alternative Dp Sensor (see page 15).

Language & Formats

Select language for display text, set format for date, time and decimal appearance.

Key Beep

Set the key beep volume between two different levels or off.

Date & Time

Set the date and time. Time is displayed on the Information bar of Handheld unit.

Information Messages

Enable/Disable the display of information messages. It can be done message by message.

Reset to Factory Settings

Reset all parameters to factory-set values. All measured and logged data are also erased.

Explanation of Function (DpS-Visio)

In the settings menu, customized adjustments of the DpS-Visio and information representation are managed.



Long press to open settings menu
 Long press to close settings menu
 Short press - jump to next screen



Arrow button to change settings



Settings are open



Change Dp measuring unit

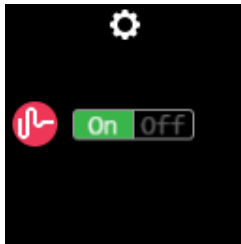

Toggle Dp filtering on/off

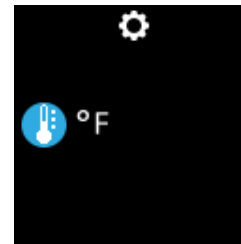

Change temperature unit



Change display brightness level

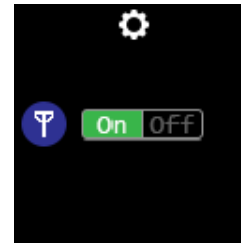

Toggle radio on/off



Change time for display auto off



Long press to close settings menu

Information

Explanation of Function



The **Information** menu displays basic system details of the Handheld, and all available sensors including;

- Available battery capacity
- Current software version and date of last update.
- Database area and version for TA valves and other IMI Hydronic Engineering information.
- Last calibration of Dp Sensor and Temperature Sensor(s). If displayed in red the calibration is older than one year and a new calibration is required.
- Pressure offset voltage

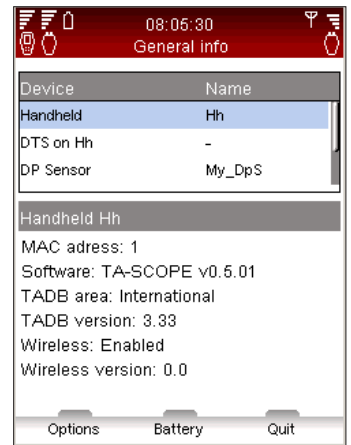

Tips! The Information details will be helpful when contacting IMI Hydronic Engineering with queries regarding your TA-SCOPE instrument.

PC Communication

Transfer of Data

Connect TA-SCOPE to your PC to transfer data, e.g., hydronic networks and collected system information to and from the HySelect software.

Use the USB-cable to connect the Handheld to a PC and the HySelect software will automatically connect to TA-SCOPE. Simply follow the instructions on the PC.

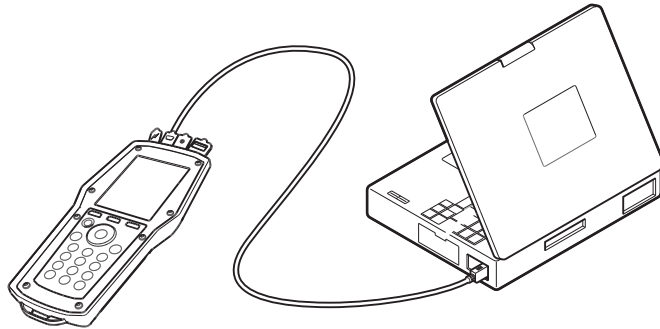

Software Upgrade

When a new version of the TA-SCOPE software is available, HySelect will automatically suggest an upgrade. Simply connect your Handheld and DpS-Visio as shown and follow the instructions on the PC.

1.

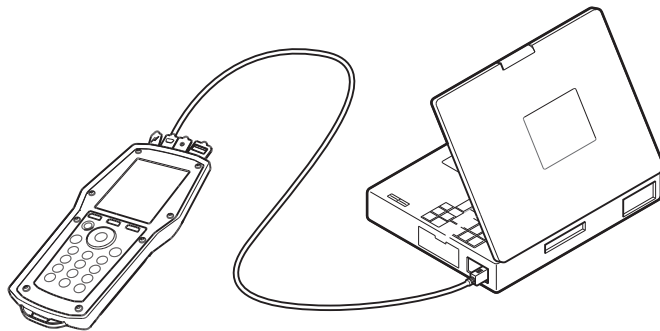

2.

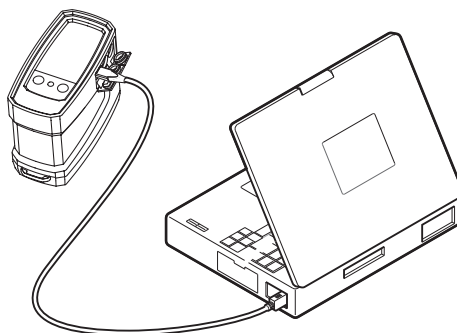

Instrument Care and Service

Care & Storage Recommendations

- TA-SCOPE can be cleansed with a dampened cloth and a lenient cleaning-agent.
- Never leave water in the Dp Sensor when risk of freezing exists (i.e., in a car during winter)!
- Do not expose to extreme temperatures, the battery may explode if disposed of in fire.
- Storage above 140° F is not allowed.
- Other usage than specified in this manual may cause damage to the unit or user.



Warning! Do not open the instrument. This can damage the instrument and void your guarantee! See page 43 for further information.

Batteries – Capacity & Charging

Upon delivery the TA-SCOPE is partly charged and prepared to start balancing immediately. The Information bar on the Handheld displays the battery status for both Handheld and Dp Sensor whenever communication is established.

The Handheld and Dp Sensor can be charged at the same time through the multi-charger. The TA-SCOPE is delivered with one multi-charger and 2 charging cables (i.e. the cable between unit and multi-charger). A charging cable is delivered with each extra TA-SCOPE unit (DpS).



Warning! Both Handheld and Dp Sensor contain batteries which require charging. The supplied multi-charger from IMI Hydronic Engineering must be used!



Tips! Maximize battery capacity by adjusting the settings for backlight, time to sleep mode and time to switch-off. **Power Saving** options are reached from the **Settings** menu.

The batteries installed in the TA-SCOPE are specifically designed for this application and may not be changed under any circumstances. Contact your local IMI Hydronic Engineering sales office if you experience any battery issues.

The time for charging from empty batteries is approximately six to seven hours and gives up to three full working days of wireless performance.

The Handheld and DpS-Visio will also charge connected to the PC during transfer of measuring data and software updates, see page 40.



Charging – Operation instruction

(Choose the correct plug (fig A).)

1. Connect the multi-charger to the wall socket. Wait for the indicator to show green colour.
2. Plug the device(s) into the USB port(s).

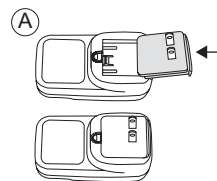

CAUTION! (Multi-charger)

1. Do not bend the blade or pins of the plug.
2. If there are any strange sound, smoke or odor, pull of the cable(s) immediately.
3. Do not disassemble. (it may cause fire or electric shock).
4. Do not put any sharp objects into the venting hole. (it may cause fire or electric shock).
5. Ensure to plug the multi-charger firmly.
6. Ensure not to use damaged cable(s). (it may cause fire or electric shock).
7. Ensure not to place the multi-charger on a bed, bag or inside a closet that is not good for ventilation.
8. Always wipe off the multi-charger with a soft fabric, not water mop. (water may cause electric shock).
9. Keep the power plug and outlet clean. (dirt may cause a short circuit and fire).
10. Keep the product out of reach of children.

Dp Sensor Battery Indicator

The DpS-Visio have a LED showing fixed or flashing green, orange or red light depending on battery status and remaining capacity.

Red light	Less than 30% battery capacity remaining
Orange light	Less than 70% battery capacity remaining
Green light	More than 70% battery capacity remaining
Fixed light	Charging completed
Flashing light 1 sec.	Charging in progress
Flashing light 2 sec.	On battery or Dp Sensor connected to Handheld for additional power supply
Flashing light 9 sec. (for Dp Sensor only)	Dp Sensor in sleep mode whilst logging is in progress. Press  during 1 second to reactivate the Dp Sensor.

Filter Cleaning

Filters in the measuring hoses protect the Dp Sensor from dirt and particles in the fluid running in the hydronic system.

Wear of the filter depends on usage, change when required to maintain optimum accuracy. A set of spare filters is delivered with the TA-SCOPE and can also be ordered as an accessory.

Clean the filter frequently, preferably after each session.

Use spanners to remove the filter holder (1), filter (2) and O-ring (3). Release and wash/replace the filter.

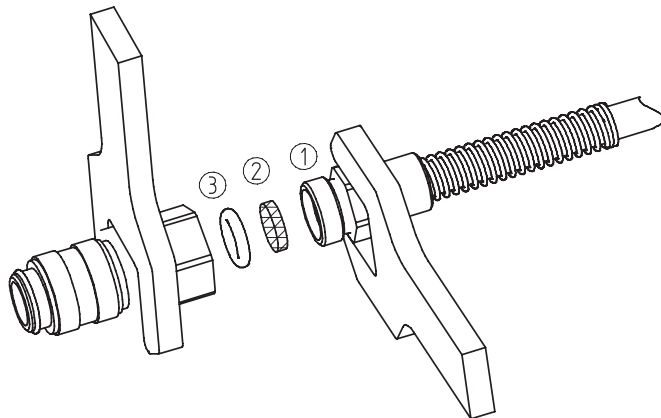

Calibration Certificates

Calibration certificates for the TA-SCOPE Dp Sensor and Digital Temperature Sensor are issued after the delivery control. The equipment used is traceable to national standards according to ISO 9001 or equivalent.

The frequency of calibration depends upon instrument usage and requirements according to corporate standards. IMI Hydronic Engineering recommends regular calibration of the Dp sensor and Digital Temperature Sensor on an annual basis to ensure optimum performance.

Guarantee

TA-SCOPE is guaranteed to be free of material or performance defects in normal use and service. The guarantee period is two years, starting from and including the day of delivery. A guarantee period of 365 days applies for repairs and service.

This guarantee applies only for the original purchaser and does not include consumable materials or measuring instruments which, in IMI Hydronic Engineering's opinion, have been used incorrectly, have been neglected or have been damaged as a result of accident or abnormal use or handling. IMI Hydronic Engineering guarantees that its software operates in all significant respects in accordance with its performance specification. IMI Hydronic Engineering does not guarantee that its software is fault free or that it will operate without crashing.

IMI Hydronic Engineering's obligations in respect of its guarantee are restricted to full replacement of the purchase cost or cost-free repair or replacement of defective products delivered to a IMI Hydronic Engineering authorised service centre during the guarantee period, at IMI Hydronic Engineering's discretion. To claim service under guarantee, either contact the nearest IMI Hydronic Engineering authorised service centre or send the product, carriage-paid (FOB) and insured, to the nearest IMI Hydronic Engineering authorised service centre with a description of the problem. IMI Hydronic Engineering does not accept the risk of damage to the product during transport. After repair under guarantee, the product will be returned carriage-paid (FOB) to the purchaser.

If IMI Hydronic Engineering is of the opinion that the fault has been caused by incorrect use, modifications, accident or abnormal use or handling, we will submit an estimate for the cost of repairs and await approval of this estimate before starting work. After repair, the product will be returned carriage-paid to the customer, after which the customer will be invoiced for the cost of repair and of returning the product (FOB).

FCC Notification and ETL Markings

TA-SCOPE complies with part 15 of the FCC Rules. Operation is subject to the following two conditions: (1) This device may not cause harmful interference, and (2) this device must accept any interference received, including interference that may cause undesired operation.



Note! Changes or modifications of the equipment, not expressly approved by the party responsible for compliance, could void the users authority to operate the equipment.

This equipment has been tested and found to comply with the limits for a Class B digital device, pursuant to part 15 of the FCC Rules. These limits are designed to provide reasonable protections against harmful interference in a residential installation. This equipment generates, uses and can radiate radio frequency energy and, if not installed and used in accordance with the instructions, may cause harmful interference to radio communications. However, there is no guarantee that interference will not occur in a particular installation. If this equipment does cause harmful interference to radio or television reception, which can be determined by turning the equipment off and on, the user is encouraged to try to correct the interference by one or more of the following measures:

- Reorientate or relocate the receiving antenna.
- Increase the separation between the equipment and receiver.
- Connect the equipment into an outlet on a circuit different from that to which the receiver is connected.
- Consult the dealer or an experienced radio/TV technician for help.



ETL LISTED:

Conforms to UL Std 61010-1.

Certified to CSA Std C22.2 No 61010-1.

Technical Specifications

Measurement range

Total pressure	
– TA-SCOPE	max. 232 psi
– TA-SCOPE HP	max. 362 psi
Differential pressure	
– TA-SCOPE	0 - 72.5 psi
– TA-SCOPE HP	0 - 145 psi
Recommended pressure range during flow measurements	
– TA-SCOPE	0.02 - 72.5 psi
– TA-SCOPE HP	0.5 - 145 psi
Temperature liquid medium measurement	-4 - +248°F

Measurement deviation

Differential pressure	
– TA-SCOPE	0.015 psi or 1% of reading, whichever is the highest
– TA-SCOPE HP	0.029 psi or 1% of reading, whichever is the highest
Flow	as for differential pressure + valve deviation
Temperature	<0.36°F

Battery capacity, operating and charge times

Handheld unit battery, capacity	4 400 mAh
– operating time (with backlight on)	>25 h
– charge time to full capacity	6-7 h
Dp sensor unit battery, capacity	1 400 mAh
– operating time (continuous measurements)	>25 h
– charge time to full capacity	2.5 h
Logging time (in sleep mode)	>100 days

Ambient temperature

During operation	+32 - +104°F
During charging	+32 - +104°F
During storage*)	-4 - +150°F

*) Do not leave water in the sensor when there is a risk of freezing.

Humidity

Ambient humidity	max. 90%RH
------------------	------------

Sealing

Handheld unit (in wireless mode)	IP 64
Dp sensor unit DpS-Visio (in wireless mode)	IP 64
Safety pressure and temperature probe	IP 65
Digital temperature sensor	IP 65

IP6X = dust tight

IPX4 = protected against splashing water

IPX5 = protected against water jets

Dimensions/Weight

Handheld unit	8.1x3.8x1.2 in, 0.8 lb.
Dp sensor unit DpS-Visio	4.7x4.7x2.2 in., 1.4 lb.

Display

Handheld	
– Size	3.5"
– Number of dots	320x240
– LCD type	TFT
– Color	262K (24BIT)
– Back light	LED WHITE
DpS-Visio	
– Size	1.5"
– Number of dots	128x128
– Type	OLED
– Color	265K

Data storage

Storage of measured data	> 2 000 valves
Logging of data (3 channels)	3 x 40 000 measuring values

Wireless

Wireless (between handheld and Dp sensor, 2.4 GHz)	
Range in open space	approx. 230 ft.
Range indoors	approx. 65-100 ft.

Multi-charger

Input voltage	100-240 VAC
Input frequency	50-60 Hz
Output voltage	5 VDC
Output current	6800 mA
Connectors	EU, UK, US, AU/NZ

Technical specifications valid at an altitude of max. 6560 ft.

Accessories

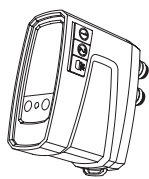

DpS-Visio (Dp sensor unit)

Included: Measuring hoses 20 in. x2, identification rings x2, safety pressure probe (SPP) x2, charging cable x1.

0-72.5 psi (0-500 kPa) (standard)

52 199-971

0-145 psi (0-1000 kPa) (HP, high pressure)

52 199-972



Digital Temperature Sensor (DTS)

52 199-941

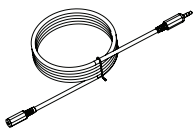

Extension cable for Digital Temperature Sensor

Length 16.4 ft

52 199-994

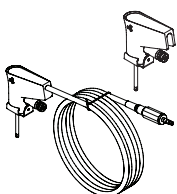

Safety probes

Safety pressure probe (SPP)

52 199-951

Safety pressure/temperature probe (SPTP)

52 199-952



Cable wrapping

To keep SPTP cable and hose together

310 355-01

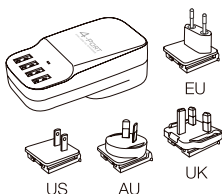

Multi-charger

Excl. charging cables

311 100-01

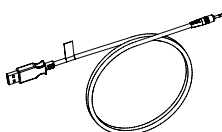

Cables

To connect or charging:

Handheld - Multi-charger

310 397-02

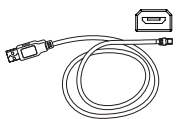

Handheld - DpS-Visio / PC - DpS-Visio / DpS-Visio - Multi-charger

310 278-02

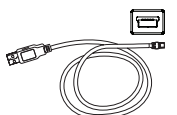

Handheld - PC / Handheld - DpS (up to 08.2017)

310 278-01



Identification rings

"DpS 1" and "DpS 2" for marking the Dp sensors when using TA-Wireless. To be placed on measuring hoses.

DpS 1

310 399-01

DpS 2

310 399-02

	Measuring Hoses	20 in., red, with shut-off valve 20 in., blue, with shut-off valve 9.8 ft, red, with shut-off valve 9.8 ft, blue, with shut-off valve	52 199-995 52 199-996 52 199-997 52 199-998
		20 in., red, with measuring needle, angle 20 in., blue, with measuring needle, angle	311 074-61 311 074-60
		20 in., red 20 in., blue	52 199-953 52 199-954
		6 in., with twin needle	52 199-999
	Spare filter	To measuring hoses	
		Filter, 1 pc (→09.2018)	309 206-01
		Filters + O-rings, 4 pcs (10.2018→)	311 062-62
	Measuring Needle, angle	Suitable for hoses 52 199-995 – -998	307 635-62
	Chucks	Chuck, red for old valves and TA-BVS Chuck, blue for old valves and TA-BVS	309 748-60 309 748-61
	Measuring Nipples	Connection thread 1/2" Connection thread 3/4"	52 197-303 52 197-304
		Extension 60 mm	52 179-006
	Spanners	Spanner for measuring points, older valves	52 187-004
		Allen key 3 mm, balancing Allen key 5 mm, draining	52 187-103 52 187-105

